

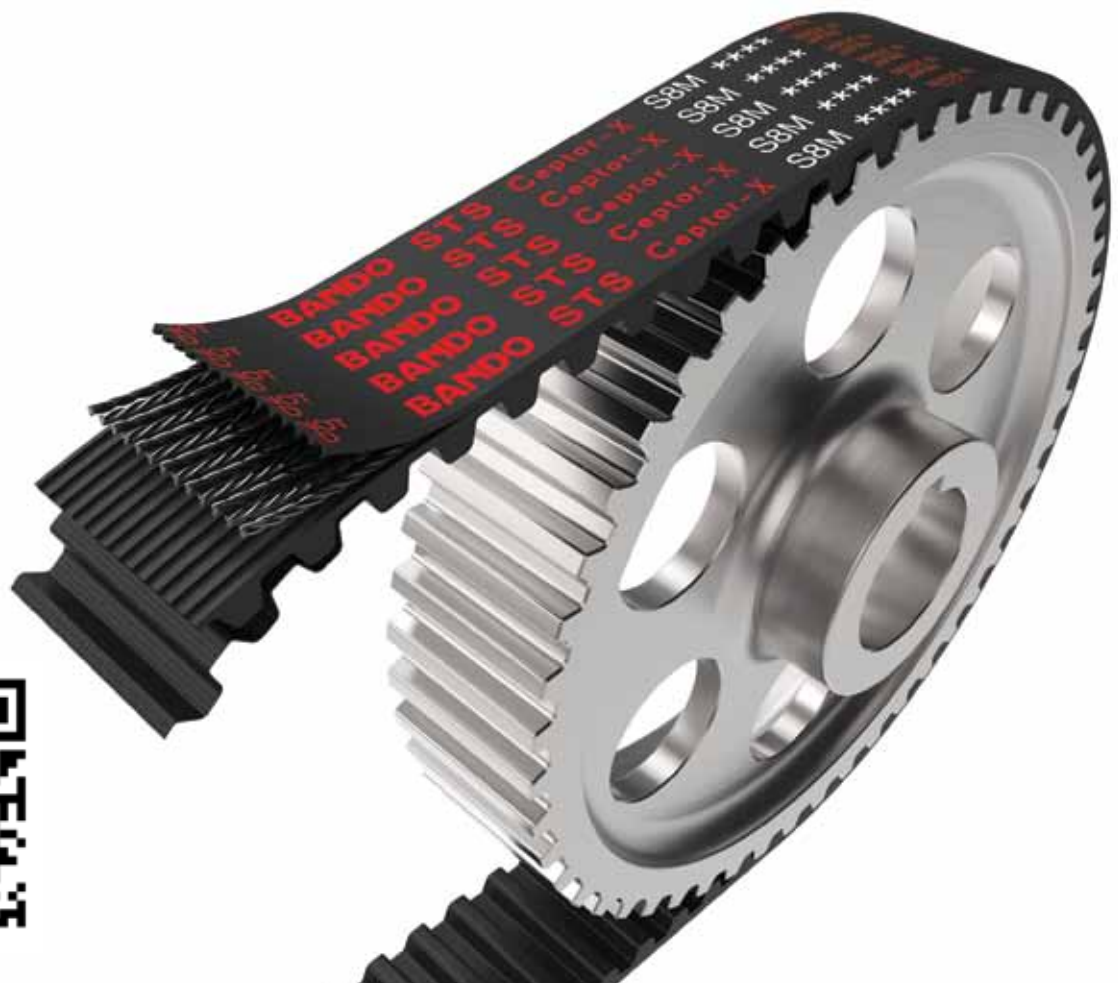

Ceptor®-X

Super torque synchronous belt  
available for high load

Ceptor®-X



Product brochure  
as PDF-File:



# FEATURES

High power ratio compared with current product.

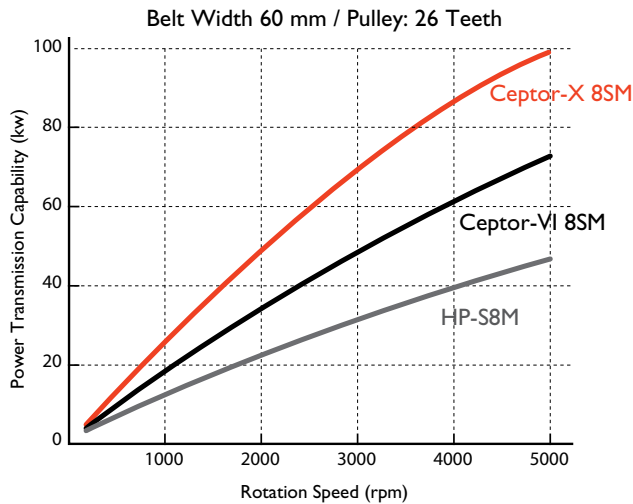

Reduced Belt Width with Ceptor-X

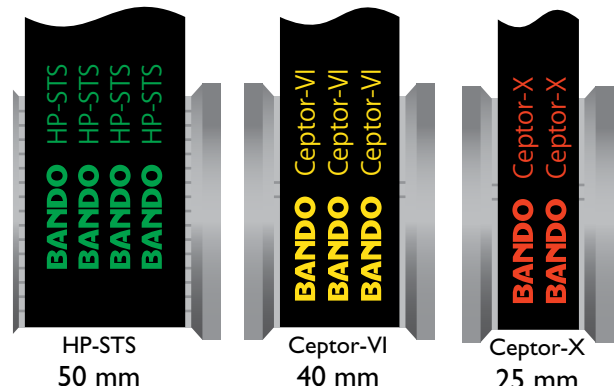

The improved design of Ceptor-X allows reduced belt and pulley widths.

# BELT STRUCTURE

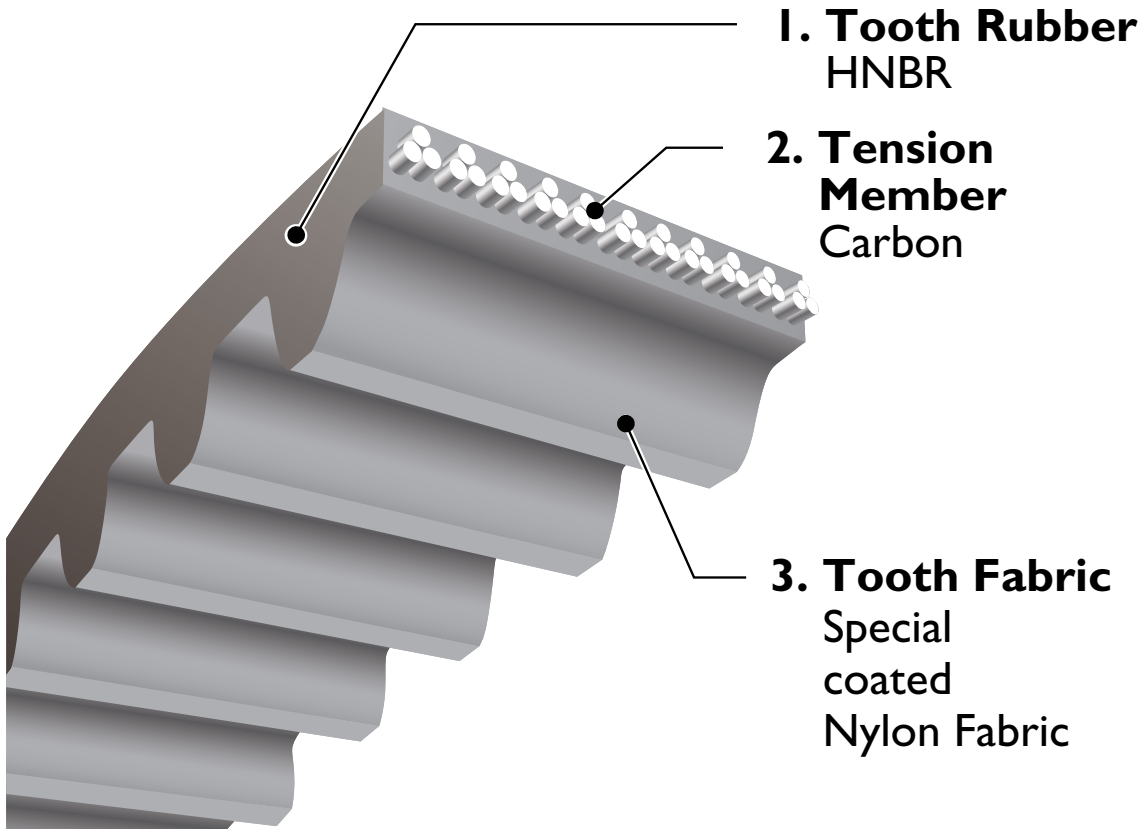

# PERFORMANCE

## Ceptor<sup>®</sup>-X advantages:

- (1) Excellent Tension Stability
- (2) High Reliability

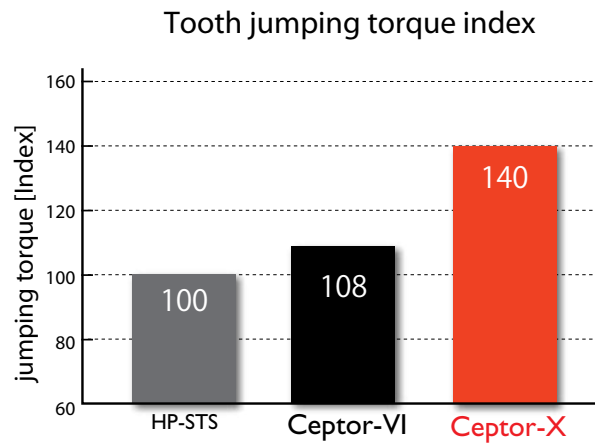
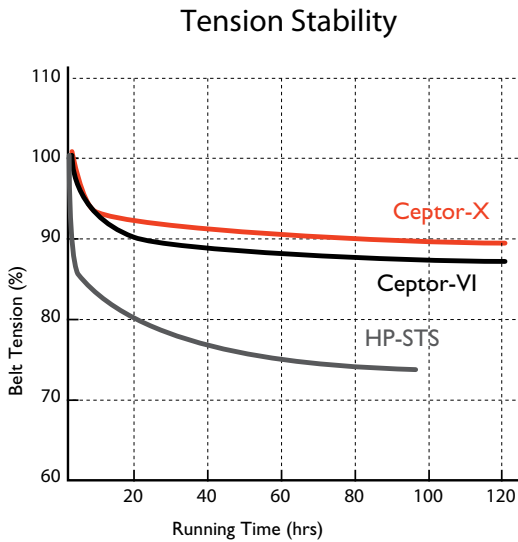

- (3) Noise Reduction
- (4) Long Life Time

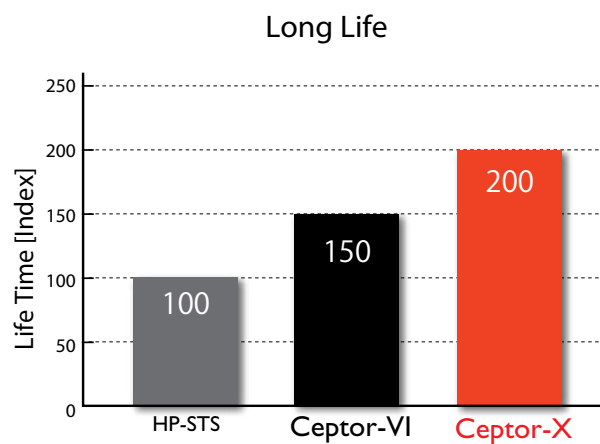
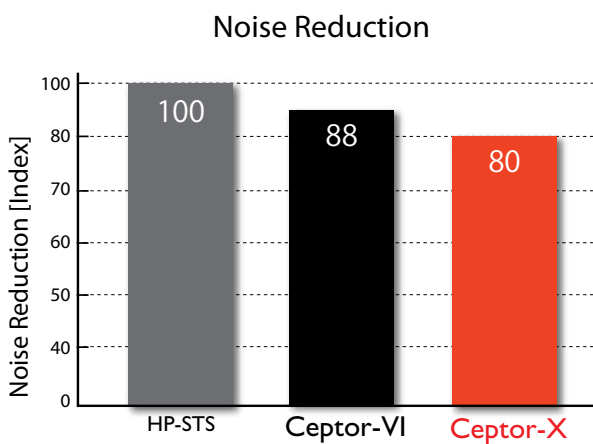

Ceptor<sup>®</sup>-X is suitable for Standard Pulleys.

## Ceptor-X S8M

Description	Pitch Length (mm)	No. of Teeth
Ceptor-X S8M 480	480.00	60
Ceptor-X S8M 496	496.00	62
Ceptor-X S8M 512	512.00	64
Ceptor-X S8M 520	520.00	65
Ceptor-X S8M 528	528.00	66
Ceptor-X S8M 560	560.00	70
Ceptor-X S8M 584	584.00	73
Ceptor-X S8M 600	600.00	75
Ceptor-X S8M 632	632.00	79
Ceptor-X S8M 640	640.00	80
Ceptor-X S8M 656	656.00	82
Ceptor-X S8M 672	672.00	84
Ceptor-X S8M 680	680.00	85
Ceptor-X S8M 712	712.00	89
Ceptor-X S8M 720	720.00	90
Ceptor-X S8M 728	728.00	91
Ceptor-X S8M 760	760.00	95
Ceptor-X S8M 800	800.00	100
Ceptor-X S8M 824	824.00	103
Ceptor-X S8M 840	840.00	105
Ceptor-X S8M 848	848.00	106
Ceptor-X S8M 880	880.00	110
Ceptor-X S8M 888	888.00	111
Ceptor-X S8M 896	896.00	112
Ceptor-X S8M 920	920.00	115
Ceptor-X S8M 944	944.00	118
Ceptor-X S8M 960	960.00	120
Ceptor-X S8M 976	976.00	122
Ceptor-X S8M 984	984.00	123
Ceptor-X S8M 1000	1000.00	125

Description	Pitch Length (mm)	No. of Teeth
Ceptor-X S8M 1032	1032.00	129
Ceptor-X S8M 1040	1040.00	130
Ceptor-X S8M 1056	1056.00	132
Ceptor-X S8M 1080	1080.00	135
Ceptor-X S8M 1096	1096.00	137
Ceptor-X S8M 1120	1120.00	140
Ceptor-X S8M 1136	1136.00	142
Ceptor-X S8M 1152	1152.00	144
Ceptor-X S8M 1160	1160.00	145
Ceptor-X S8M 1184	1184.00	148
Ceptor-X S8M 1192	1192.00	149
Ceptor-X S8M 1200	1200.00	150
Ceptor-X S8M 1216	1216.00	152
Ceptor-X S8M 1224	1224.00	153
Ceptor-X S8M 1240	1240.00	155
Ceptor-X S8M 1248	1248.00	156
Ceptor-X S8M 1272	1272.00	159
Ceptor-X S8M 1280	1280.00	160
Ceptor-X S8M 1296	1296.00	162
Ceptor-X S8M 1312	1312.00	164
Ceptor-X S8M 1344	1344.00	168
Ceptor-X S8M 1352	1352.00	169
Ceptor-X S8M 1360	1360.00	170
Ceptor-X S8M 1384	1384.00	173
Ceptor-X S8M 1392	1392.00	174
Ceptor-X S8M 1400	1400.00	175
Ceptor-X S8M 1424	1424.00	178
Ceptor-X S8M 1440	1440.00	180
Ceptor-X S8M 1480	1480.00	185
Ceptor-X S8M 1520	1520.00	190

Description	Pitch Length (mm)	No. of Teeth
Ceptor-X S8M 1552	1552.00	194
Ceptor-X S8M 1600	1600.00	200
Ceptor-X S8M 1648	1648.00	206
Ceptor-X S8M 1680	1680.00	210
Ceptor-X S8M 1728	1728.00	216
Ceptor-X S8M 1760	1760.00	220
Ceptor-X S8M 1776	1776.00	222
Ceptor-X S8M 1800	1800.00	225
Ceptor-X S8M 1808	1808.00	226
Ceptor-X S8M 1856	1856.00	232
Ceptor-X S8M 1880	1880.00	235
Ceptor-X S8M 1912	1912.00	239
Ceptor-X S8M 1952	1952.00	244
Ceptor-X S8M 2000	2000.00	250
Ceptor-X S8M 2040	2040.00	255
Ceptor-X S8M 2120	2120.00	265
Ceptor-X S8M 2160	2160.00	270
Ceptor-X S8M 2240	2240.00	280
Ceptor-X S8M 2304	2304.00	288
Ceptor-X S8M 2400	2400.00	300
Ceptor-X S8M 2496	2496.00	312
Ceptor-X S8M 2560	2560.00	320
Ceptor-X S8M 2600	2600.00	325
Ceptor-X S8M 2800	2800.00	350
Ceptor-X S8M 2880	2880.00	360
Ceptor-X S8M 2944	2944.00	368
Ceptor-X S8M 3200	3200.00	400
Ceptor-X S8M 3600	3600.00	450
Ceptor-X S8M 3720	3720.00	465
Ceptor-X S8M 3904	3904.00	488
Ceptor-X S8M 4400	4400.00	550

## Ceptor-X S14M

Description	Pitch Length (mm)	No. of Teeth
Ceptor-X S14M1008	1008.00	72
Ceptor-X S14M1120	1120.00	80
Ceptor-X S14M1190	1190.00	85
Ceptor-X S14M1246	1246.00	89
Ceptor-X S14M1400	1400.00	100
Ceptor-X S14M1540	1540.00	110
Ceptor-X S14M1610	1610.00	115
Ceptor-X S14M1652	1652.00	118
Ceptor-X S14M1778	1778.00	127
Ceptor-X S14M1806	1806.00	129
Ceptor-X S14M1890	1890.00	135

Description	Pitch Length (mm)	No. of Teeth
Ceptor-X S14M 1904	1904.00	136
Ceptor-X S14M 1960	1960.00	140
Ceptor-X S14M 2002	2002.00	143
Ceptor-X S14M 2100	2100.00	150
Ceptor-X S14M 2240	2240.00	160
Ceptor-X S14M 2310	2310.00	165
Ceptor-X S14M 2380	2380.00	170
Ceptor-X S14M 2450	2450.00	175
Ceptor-X S14M 2506	2506.00	179
Ceptor-X S14M 2590	2590.00	185
Ceptor-X S14M 2660	2660.00	190

Description	Pitch Length (mm)	No. of Teeth
Ceptor-X S14M 2800	2800.00	200
Ceptor-X S14M 3150	3150.00	225
Ceptor-X S14M 3248	3248.00	232
Ceptor-X S14M 3500	3500.00	250
Ceptor-X S14M 3556	3556.00	254
Ceptor-X S14M 3850	3850.00	275
Ceptor-X S14M 4004	4004.00	286
Ceptor-X S14M 4060	4060.00	290
Ceptor-X S14M 4326	4326.00	309
Ceptor-X S14M 4508	4508.00	322
Ceptor-X S14M 5012	5012.00	358

\* Please note that this catalogue is reserved to changes. All data in this publication have been compiled and checked with utmost diligence, nevertheless errors and mistakes cannot be totally excluded. Do not duplicate or copy any part or contents without the permission of Bando Europe GmbH.